



NEOS

SEMI AUTOMATIC PALLET WRAPPER
MAINTENANCE FREE

**Semi automatic robot
for wrapping pallets with stretch film**



NEOS
Input: 230 Volt
1 PHASE



NEW DESIGN, NEW PANEL, NEW SOLUTIONS

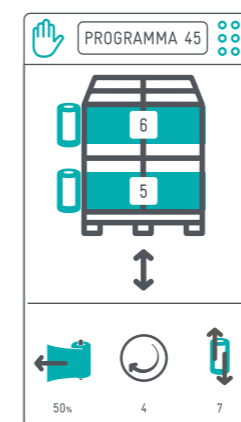

USER FRIENDLY EXPERIENCE

- IT** Il nuovo pannello touch da 7 pollici, l'utente ha un nuovo modo di impostare i programmi per il miglior risultato di avvolgimento.
- EN** New 7-inch touch panel, challenge the user to setup an explore ways, for the best wrapping result.
- FR** Le nouvel écran touch de 7 pouces, l'utilisateur dispose d'une nouvelle façon de régler les programmes pour le meilleur résultat d'emballage.
- DE** Mit dem neuen 7-Zoll-Touchpanel hat der Benutzer eine neue Möglichkeit, Programme für das beste Wicklergebnis einzustellen.
- ES** El nuevo panel touch de 7 pulgadas, el usuario tiene una nueva forma de configurar los programas para obtener el mejor resultado de envoltura.

SAFETY SCAN-SYSTEM



- IT** Questo optional sostituisce la bandella anteriore: se durante l'avvolgimento viene rilevato un ostacolo il Robot rallenta fino a fermarsi evitando qualsiasi contatto con l'operatore. L'arco luminoso in dotazione con il sistema identifica l'area di lavoro del Robot.
- EN** This optional makes the robot bumperless: if an obstacle is detected during wrapping, the robot slows down to a stop, avoiding any contact with the operator. The light arc supplied with the system identifies the robot's working area.
- FR** Cette option remplace la bande frontale : si un obstacle est détecté pendant l'emballage, le robot ralentit jusqu'à l'arrêt, en évitant tout contact avec l'opérateur. L'arc lumineux fourni avec le système permet d'identifier la zone de travail du robot.
- DE** Diese Option ersetzt den vorderen Sicherheitsbügel: wenn ein Hindernis erkannt wird, verlangsamt die Maschine, wenn der Bereich noch nicht frei ist und der Mindestabstand nicht erreicht ist, stoppt die Maschine vollständig.
- ES** Este accesorio opcional sustituye a la banda frontal: si se detecta un obstáculo durante la envoltura, el robot ralentiza hasta detenerse, evitando cualquier contacto con el operario. El arco luminoso incluido con el sistema identifica la zona de trabajo del robot.

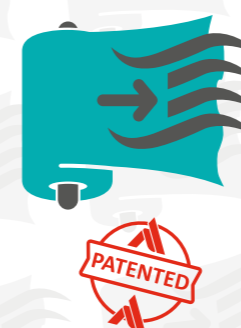

ARYA SYSTEM

- IT** Brevetto rivoluzionario che porta l'automazione a portata di mano senza investimenti significativi.
- EN** Revolutionary patent which brings automation within reach without significant investments.
- FR** Un modèle révolutionnaire qui met l'automatisation à portée de main sans investissements importants.
- DE** Revolutionäres Patent, das die Automatisierung ohne erhebliche Investitionen in greifbare Nähe rückt.
- ES** Patente revolucionaria que pone la automatización al alcance sin inversiones significativas.

PALLET DIMENSIONS

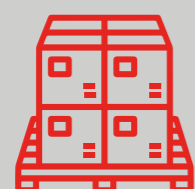
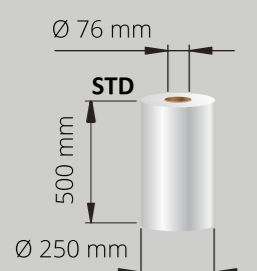

H mm Mast
2200 STD
2400 OPT
2700 OPT
3000 OPT
3500 OPT

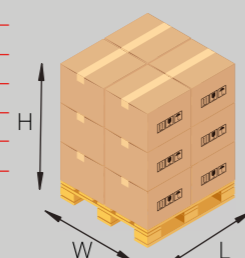

WxL mm Neos	
MIN	MAX Ø
650x400	∞ No limits

APPLICATIONS





ATLANTA STRETCH SELLING POINTS

EXCHANGEABLE CARRIAGES



- IT** Carrelli porta bobina intercambiabili anche dopo la consegna della macchina con un notevole risparmio.
- EN** The carriage can be upgraded even after delivery, to achieve lower costs of ownership.
- FR** Le chariot peut être mis à niveau même après la livraison, afin de réduire les coûts de possession.
- DE** Austauschbarer Folienschlitten auch nach Auslieferung der Maschine, zur Reduzierung der Betriebskosten
- ES** El carro se puede intercambiar incluso después de la entrega, para lograr menores costos de operación.

ERGONOMIC SOLUTION FOR THE USER



- IT** L'attenzione alla sicurezza e al massimo comfort del lavoratore contribuiscono a migliorare la qualità del lavoro, diminuendo lo stress a favore della soddisfazione generale dell'utente
- EN** For the highest security and safety of the user and to achieve a better working, and higher satisfaction of the user.
- FR** Pour la plus grande sécurité et sûreté de l'utilisateur et pour obtenir un meilleur environnement de travail et une plus grande satisfaction de l'utilisateur.
- DE** Für höchste Sicherheit des Nutzers, sowie zur Erreichung eines besseren Arbeitsumfelds und Zufriedenheit
- ES** Para la mayor seguridad y protección del usuario, mejor calidad de trabajo y una mayor satisfacción del usuario.

COMMERCIAL COMPONENTS AVAILABLE ON THE FREE MARKET



- IT** La facilità con cui i nostri componenti sono reperibili sul mercato contribuisce ad abbatterne il prezzo con notevole risparmio per l'utente.
- EN** The use of commercial components in all our products means higher reliability and lower costs but also flexibility in terms of spare parts.
- FR** La façon dont nous nous approvisionnons et spécifions des niveaux élevés pour les composants de nos produits, signifie que vous bénéficierez de niveaux de fiabilité élevés et constants
- DE** Der Einsatz handelsüblicher Komponenten in all unseren Produkten bedeutet höhere Zuverlässigkeit und geringere Kosten, aber auch Flexibilität bei der Materialversorgung.
- ES** El uso de componentes comerciales en todos nuestros productos significa mayor confiabilidad y menores costos, pero también flexibilidad en términos de suministro de repuestos.

POSSIBILITY TO ADJUST TENSION ON LOAD AND PRE STRETCH IN EVERY STEP OF THE WRAPPING CYCLE



- IT** I nostri carrelli offrono la possibilità di regolare in maniera mirata la tensione del film e il prestiro in ogni fase dell'avvolgimento.
- EN** Our carriages are standard equipped with the possibility to adjust film tension and pre-stretch during every phase of the wrapping process.
- FR** Nos chariots sont tous équipés en mode standard avec la possibilité de régler la tension du film et de le pré-étirer à chaque étape du processus d'emballage.
- DE** Unsere Folienschlitten sind so konzipiert, dass sowohl die Anlegespannung als auch die Folienvordehnung in jeder Phase des Wickelzyklus regulierbar sind.
- ES** Nuestros carros están equipados de serie con la posibilidad de ajustar la tensión de la película y preestirar durante cada fase del proceso de envoltura.



OPERATING PANEL

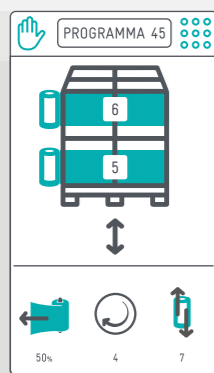

EASY TO USE 7" easy to use touch display

Neos

- IT** Imposta e avvia il tuo ciclo di avvolgimento con pochi semplici comandi.
- EN** Set and start your wrapping cycle with a few simple commands.
- FR** Réglez et démarrez votre cycle d'emballage avec quelques commandes simples.
- DE** Stellen Sie Ihren Verpackungszyklus mit ein paar einfachen Befehlen ein und starten Sie ihn.
- ES** Configure e inicie su ciclo de envoltura con unos simples comandos



MAIN FEATURES

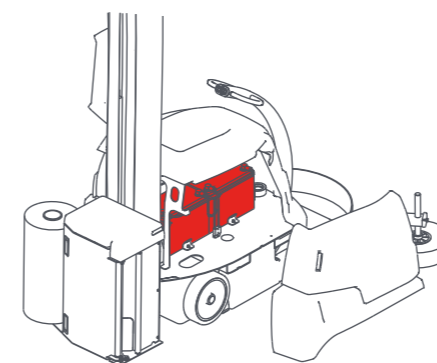
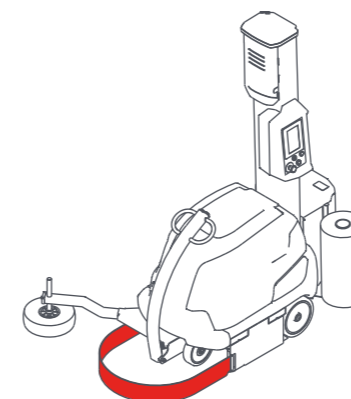
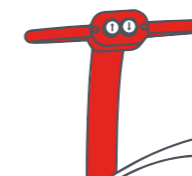
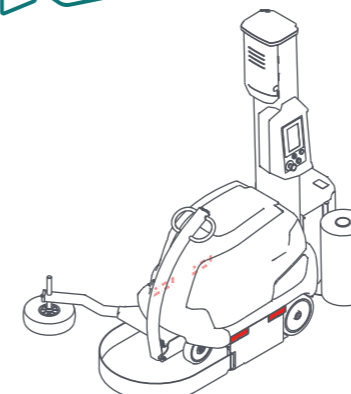

FORK SLOTS ON BOTH SIDES FOR EASY TRANSPORT



- IT** Trasporto facile.
- EN** Easy transport.
- FR** Transport facile.
- DE** Einfachen transport.
- ES** Facil transporte.

MANUAL MACHINE MOVEMENT

- IT** Timone per spostare facilmente il robot nell'area di lavoro.
- EN** Steering arm for move automatically the robot inside the workplace.
- FR** Bras de direction pour déplacer automatiquement le robot à l'intérieur du lieu de travail.
- DE** Lenkarm zum automatischen Bewegen des Roboters innerhalb des Arbeitsplatzes.
- ES** Brazo de dirección para mover automáticamente el robot dentro del lugar de trabajo.

SAFETY BUMPER

- IT** Paraurti di sicurezza in policarbonato, resistente agli urti e affidabile.
- EN** Polycarbonate safety bumper, impact-proof and reliable safety.
- FR** De sécurité en polycarbonate i, résistant aux chocs et fiable.
- DE** Sicherheitsstoßstange aus Polycarbonat, schlagfest und zuverlässig.
- ES** Parachoques de seguridad de policarbonato, a prueba de golpes y fiable.

SEALED BATTERIES

- IT** Batterie sigillate senza manutenzione: nessuna restrizione sul trasporto e possibilità di ricaricare il robot nell'area di lavoro.
- EN** Maintenance-free sealed batteries: no transport restrictions and possibility to recharge the robot at the working area.
- FR** Batterie étanche sans entretien: aucune restriction de transport et possibilité de recharger le robot dans la zone de travail.
- DE** Wartungsfreie versiegelte Batterien: keine Transportbeschränkungen und Möglichkeit den Roboter im Arbeitsbereich aufzuladen.
- ES** Baterías selladas sin mantenimiento: sin restricciones de transporte y posibilidad de recargar el robot en zona de trabajo.

WRAPPING PROGRAMS

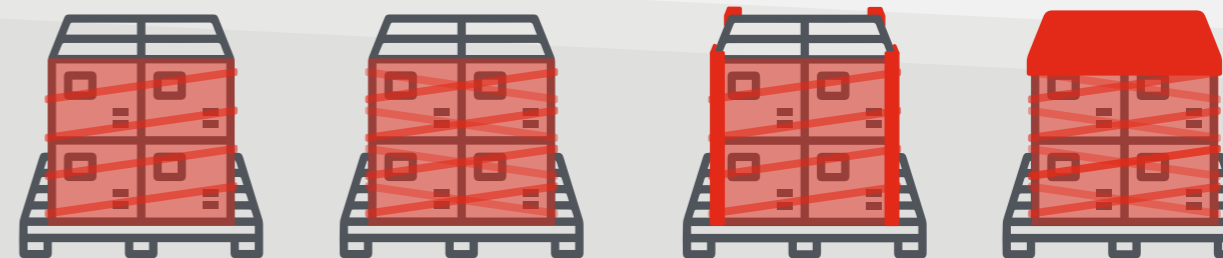



EASY FILM CHANGE

- IT** Cambio film semplificato, altezza di arresto del carrello porta bobina automatico.
- EN** Easy reel change, adjustable service height.
- FR** Changement de bobine facile, hauteur de service réglable.
- DE** Einfacher Folienwechsel in ergonomischer Arbeitshöhe.
- ES** Cambio fácil de bobina, altura de servicio ajustable.



FM

- IT** Freno meccanico regolabile manualmente.
- EN** Mechanical brake manually adjustable.
- FR** Frein mécanique ajustable manuellement.
- DE** Mechanische Bremse auf Umlenkwalze.
- ES** Fricción mecánica regulable manualmente.

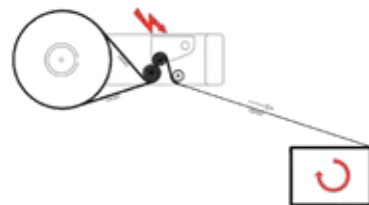

FE

- IT** Frizione elettromagnetica regolabile da pannello comandi.
- EN** Electromagnetic friction adjustable from control panel.
- FR** Frein électromagnétique réglable depuis le panneau de commande.
- DE** Elektromagnetische Bremse auf Umlenkwalze vom Bedienpult instellbar.
- ES** Fricción electromagnética regulable desde el panel de comandos.

PRS POWER ROLLER STRETCH

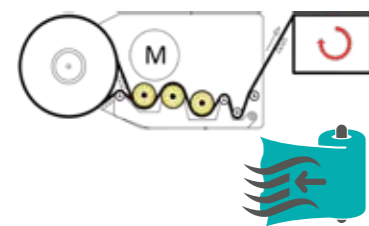

POSSIBILITY OF ARYA SYSTEM INSTALLATION

- IT** Sistema di prestiro motorizzato a 3 rulli comandato elettronicamente con rapporti intercambiabili disponibili su richiesta: 150- 200- 250%.
- EN** Motorized pre-stretch system with 3 driven rollers electronically controlled with interchangeable ratios on request: 150- 200- 250%.
- FR** Système de pré-étirage motorisé et asservi à 3 rouleaux, rapports interchangeables disponible sur demande: 150- 200- 250%.
- DE** Angetriebener Vordehnssystem mit 3 Vordehnrollen, elektronisch gesteuert mit leicht wechselbarer Zahnradsätzen auf anfrage erhältlich: 150- 200- 250%.
- ES** Sistema de prestiro motorizado con 3 rodillos, comandado electrónicamente con desarrollos intercambiables disponible previa demanda: 150- 200- 250%.

PS POWER STRETCH

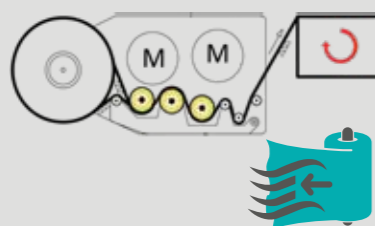

POSSIBILITY OF ARYA SYSTEM INSTALLATION

- IT** Sistema di motorizzato a 3 rulli con 2 motori e variazione da 120 a 350% regolabile da quadro comandi.
- EN** Motorized pre-stretch system with 3 driven rollers and 2 motors adjustable between 120 to 350% from control panel.
- FR** Système de pré-étirage motorisé et asservi à 3 rouleaux et 2 moteurs, rapport ajustable de 120 à 350% depuis le panneau de commande.
- DE** Angetriebener Vordehnssystem mit 3 Vordehnrollen und 2 Motoren, stufenlos regelbare Werte zwischen 120 und 350% von Bedienpult.
- ES** Sistema de prestiro motorizado con 3 rodillos y 2 motores, regulable de 120 a 350% desde el panel de comandos.

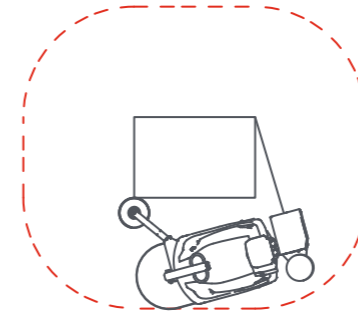

GEO MAGNETIC COMPASS (GMC)

- IT** Sistema con bussola GeoMagnetica per avere la stessa posizione di partenza e di arresto del robot anche in caso di avvolgimento di pallets aventi dimensioni molto grandi.
- EN** Geo Magnetic Compass, having the starting and stopping position at the same point, in those special cases where you have to wrap oversized pallets.
- FR** Boussole Geo Magnétique, pour avoir le point de départ et de fin de cycle au même endroit, dans le cas particulier où le banderolage doit être pratiqué sur des palettes de grandes dimensions.
- DE** Geomagnetischer Kompass, Maschine stoppt immer in der Startposition.
- ES** Brújula Geo Magnética, teniendo el punto de inicio y de parada en el mismo punto, para esos casos especiales en los que tiene que envolver palés de gran tamaño.

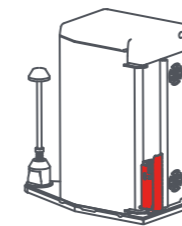

AUTOMATIC FILM CUT (FE AND OPRS CARRIAGES)

- IT** Sistema di taglio automatico del film a fine ciclo.
- EN** Automatic Film cutting Device at cycle end.
- FR** Coupe automatique du film.
- DE** Automatische Folienschneidvorrichtung am Zyklusende.
- ES** Sistema automatico de corte del film al fin del ciclo.

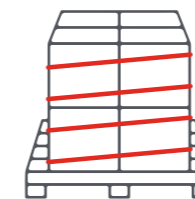

ROPING SYSTEM

- IT** Sistema di cordatura film: Permette di ridurre l'altezza del film formando un cordone che assicura una più efficiente stabilizzazione del carico.
- EN** Roping System: Reducing the film width to form a rope to ensure more effective load stabilisation.
- FR** Systeme permettant de réduire la laize du film en formant un cordon qui assure une meilleure stabilisation de la charge.
- DE** Schnurrvorrichtung: Reduzierung der Folienbreite zur Schnur um eine bessere Stabilisierung der Ladung zu gewährleisten.
- ES** Sistema de Cordón: permite reducir el ancho del film formando un cordón que asegura eficientemente la estabilidad de la carga.

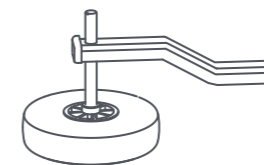

GUIDING WHEEL

- IT** Ruote guida di varie dimensioni per garantire un ciclo di avvolgimento perfetto anche con pallet di forma irregolare.
- EN** Various wheel dimensions, to guarantee a perfect wrapping pattern on pallets with a not regular shape.
- FR** Différentes dimensions de roues palpeuses, pour garantir un contact optimal sur des palettes hors standard.
- DE** Abtasträder in verschiedenen Abmessungen um ein perfektes Wicklergebnis bei Paletten außerhalb vom Standard zu gewährleisten.
- ES** Ruedas de varias dimensiones, para garantizar una envoltura perfecta, en pallets no estándar.

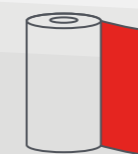

FILM WEIGHTING SYSTEM

- IT** Sistema elettronico per la indicazione del peso del film estensibile utilizzato.
- EN** Integrated calculation system, to indicate the weight of the used stretchfilm.
- FR** Système de calcul intégré pour indiquer le poids de film utilisé.
- DE** Integriertes Berechnungssystem, um das Gewicht des verwendeten Stretchfilms anzuzeigen.
- ES** Sistema integrado que indica el peso del plástico utilizado.

SEMI AUTOMATIC RANGE

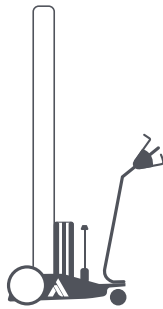

MARATHON

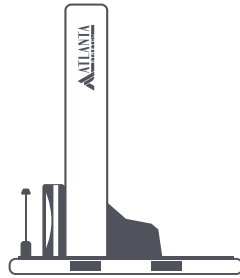

EVA

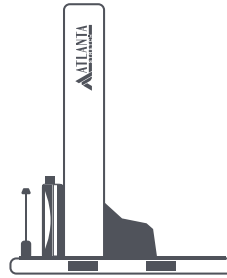

SYNTHESI

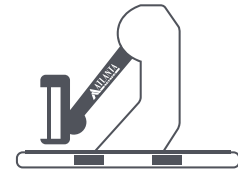

SYNTHESI ARM

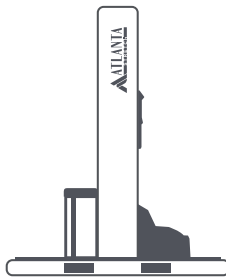

MYTHO S



SFERA ARM

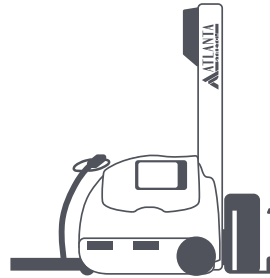

SFERA MAST



NEOS

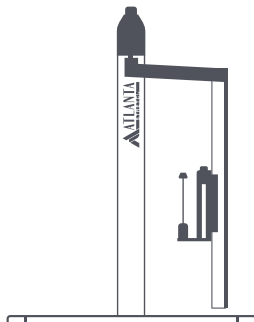

LYBRA EASY

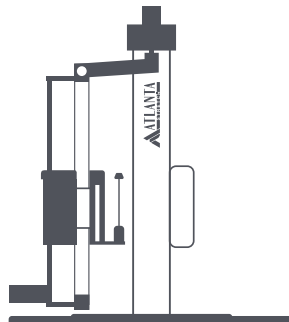

LYBRA S

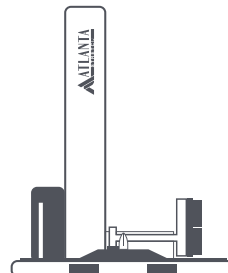

MYTHO AUTO

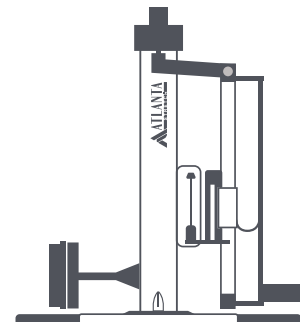

LYBRA AUTO

Atlanta Stretch Authorized dealer



Headquarter: Atlanta Stretch Italy Spa

Subsidiaries: Atlanta Stretch Australia - Atlanta Stretch China - Atlanta Stretch Deutschland - Atlanta Stretch France - Atlanta Stretch Iberica - Atlanta Stretch India - Atlanta Stretch Mexico - Atlanta Stretch Russia - Atlanta Stretch SEA - Atlanta Stretch Sweden - Atlanta Stretch Turkey - Atlanta Stretch UK



View all optional tools here

www.atlantastretch.com



Find all our dealers